



PRIME
INDUSTRIES, INC.

**MARINE
HARDWARE**

Table of Contents

Deck Cleats	1-2
Chocks	2
Deck Fills	3
Top Fittings	4-6
Pull Pins & Accessories	6-7
Noise Reduction Top Fittings	NEW! 7
Snap Hooks & Additional Hardware	8
Hawse Pipes	8
Bollards	8
Thru Hulls	9
Bow Eyes	9
Rod Holders	10-12
Rod Holder Accessories	13
Other Parts	13
Base Rail Fittings	NEW! 14-15
Elbows	NEW! 15
Tee Rail Fittings	NEW! 16
Large Rail Fittings	NEW! 16-17
Hand Rail Fittings	17
Rings	18
Hinges	18-19
End Caps	20-22
Specialty Items	23-24
Rod Holders with Logos	25
Nylon Parts	26-27
Die Cast Parts	28
Index by Part Number	29-30
Product Warranty	31
Alphabetical Index	32
Terms and Conditions	33

Prime Industries, Inc.

A service oriented Company headquartered in Virginia Beach, Virginia, Prime Industries has been providing quality stainless steel marine hardware throughout the industry for over 20 years.

All of our stainless steel products are manufactured to meet ASTM CF8M stainless steel alloy standards and are passivated. Quality is ensured through routine visual inspections, laboratory testing, and salt spray testing.

By being centrally located on the East Coast and keeping our warehouse well stocked with a large volume of products, we are able to provide fast and immediate service to our customers.

In addition, we are able to quickly and efficiently engineer and manufacture any **proprietary products** to meet your unique requirements.

Prime Industries, Inc.

525 Central Drive
Virginia Beach, Virginia 23454

Toll Free 800-446-1144

Phone 757-631-8899

Fax 757-631-0777

www.prime-industries.biz

Deck Cleats

P/N	Length	Installed Height	Fastener
87001	6"	1.2"	1/4" (4)
87002	8"	1.4"	1/4" (4)
87003	10"	1.8"	5/16" (4)
87004	12"	2.1"	5/16" (4)



Hollow Base Cleats

P/N	Length	Installed Height	Fastener
87002H	8"	1.8"	1/4" (4)
87003H	10"	2.1"	5/16" (4)



Hollow Base Cleats with 1" Clearance

P/N	Length	Installed Height	Fastener
87005	8"	2.2"	1/4" (4)
87006	10"	2.4"	5/16" (4)
87007	12"	2.75"	5/16" (4)



Heavy Duty Hollow Base Cleats

P/N	Length	Installed Height
84001	10"	1.8"



Hollow Base Cleat with Threaded Round Base

P/N	Length	Installed Height
84002	10"	3.2"



Hollow Base Cleat with 2-1/2" Stud, Round Base

P/N	Length	Installed Height	Stud Size
86032	6"	1-1/8"	5/16" Stud, 1-3-4" Long
86033	8"	1-3/8"	1/2" Stud, 2-1/4" Long
86034	10"	1-13/16"	1/2" Stud, 2-1/2" Long
86035	12"	2-1/2"	5/8" Stud, 3-1/4" Long



Sleek Cleats

◆◆ ALL PRODUCTS ARE STAINLESS STEEL UNLESS OTHERWISE NOTED ◆◆

TO ORDER, CALL PRIME INDUSTRIES, INC. 1-800-446-1144

Deck Cleats

Pull-Up Cleats	P/N	A	B	C		E	F	Stud Size
		Length	Width	Above Deck Lowered	Above Deck Raised	Line Opening	Stud Length	
	87446	6"	1-3/16"	9/16"	1-13/16"	1-1/4"	2-1/4"	5/16"
	87457	8"	1-7/16"	9/16"	1-13/16"	1-1/4"	2-3/8"	5/16"

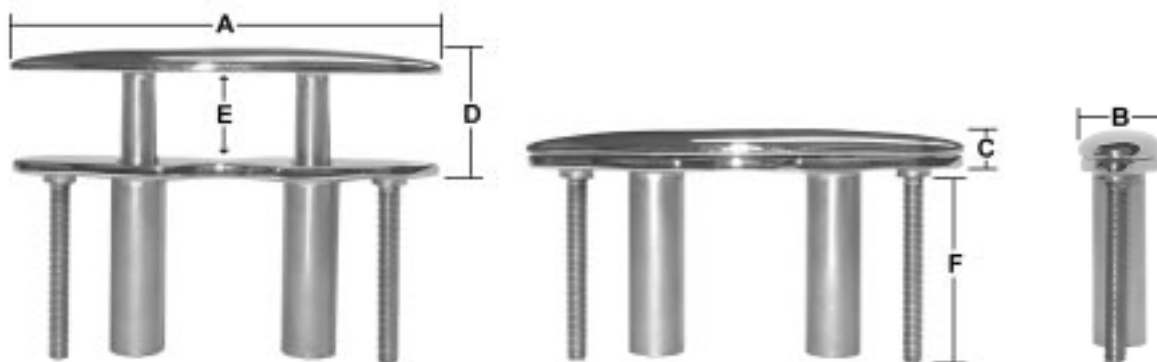

Chocks

Skene Bow Chocks	P/N	Unit	Length	Suggested Line Size	Fastener
	87011	Pr.	4-1/2"	1/2"	#10 (2)
	87012	Pr.	6"	3/4"	1/4" (2)

Prime Industries, Inc. has developed rounded edges on their chocks to reduce line fraying.

Bow Chocks	P/N	Unit	Length	Suggested Line Size	Fastener
	87013	Pr.	4-1/2"	1/2"	#10 (2)
	87014	Pr.	6"	3/4"	1/4" (2)

Prime Industries, Inc. has developed rounded edges on their chocks to reduce line fraying.

Straight Chocks	P/N	Unit	Length	Suggested Line Size	Fastener
	87015	Ea.	5"	5/8"	#10 (2)
	87016	Ea.	6"	3/4"	1/4" (2)

Prime Industries, Inc. has developed rounded edges on their chocks to reduce line fraying.

◆◆ ALL PRODUCTS ARE STAINLESS STEEL UNLESS OTHERWISE NOTED ◆◆

TO ORDER, CALL PRIME INDUSTRIES, INC. 1-800-446-1144

Deck Fills

P/N	Size	Type	Fastener	Chain
86031	1-1/2"	Gas	#10 (3)	Yes

All caps complete with washer seal installed.



Pipe Deck Fill With Key

P/N	Size	Type	Fastener	Chain
87137 (a.)	1-1/2"	Oil	#10 (3)	Yes
87138 (b.)	1-1/2"	Gas	#10 (3)	Yes

87139 (c.)	1-1/2"	Diesel	#10 (3)	Yes
87140 (d.)	1-1/2"	Water	#10 (3)	Yes

87141 (e.)	1-1/2"	Waste	#10 (3)	No
87141/L (f.)	1-1/2"	Waste (w/Large Flange)	#10 (3)	No

87401 (g.)	1-1/2"	Gas (Angled "Gas" Vertical)	#10 (3)	Yes
------------	--------	--------------------------------	---------	-----

87402 (h.)	1-1/2"	Gas (Angled "Gas" Horizontal)	#10 (3)	Yes
------------	--------	----------------------------------	---------	-----

All caps complete with washer seal installed.

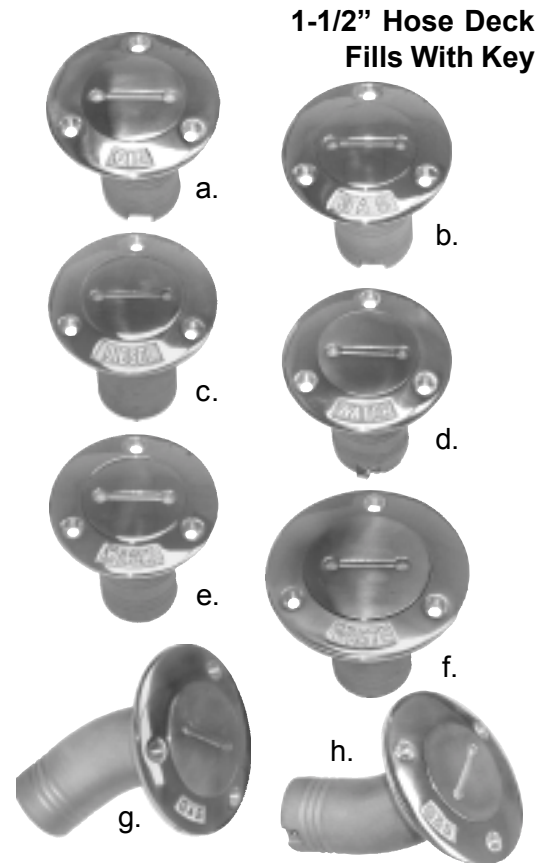

1-1/2" Hose Deck Fills With Key

P/N	Size	Type	Fastener	Chain
87521D (a.)	2"	Diesel	# 10 (3)	Yes
87521G (b.)	2"	Gas	# 10 (3)	Yes

All caps complete with washer seal installed.

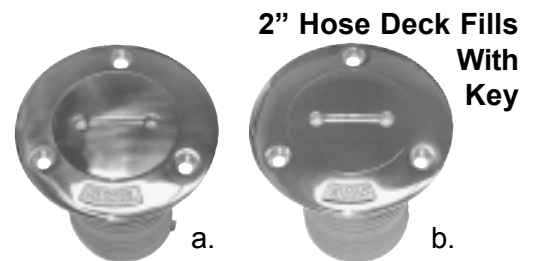

2" Hose Deck Fills With Key

P/N	Description
87142	Cap & Chain for 1.5"
87141/L-1	Cap & Chain for 2"
87146	Key

All caps complete with washer seal installed.



Deck Fills Accessories Or Replacements

◆◆ ALL PRODUCTS ARE STAINLESS STEEL UNLESS OTHERWISE NOTED ◆◆

TO ORDER, CALL PRIME INDUSTRIES, INC. 1-800-446-1144

Top Fittings

Top Caps

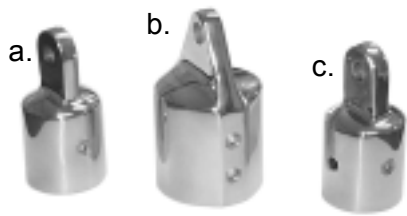

P/N		Tube Size	Pin Size	Description
87079	(a.)	7/8"	1/4"	1/4-28 Set Screw
87080		1"	1/4"	1/4-28 Set Screw
87516		3/4"	1/4"	1/4-28 Set Screw
87518	(b.)	1-1/4"	5/16"	1/4-28 Set Screws (2)
87432	(c.)	7/8"	1/4"	One 1/4-28 Set Screw & One 3/16" Rivet Hole
87472		7/8"	1/4"	Two 3/16" Rivet Holes

Eye End Plugs

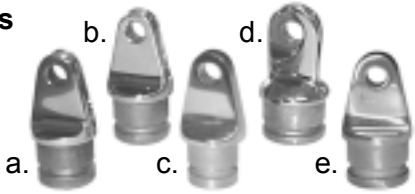

P/N		Tube Size	Pin Size	Description
86006	(a.)	7/8"	1/4"	for 19.5mm Shank
86009	(b.)	7/8"	1/4"	for 18.8mm Shank
86043	(c.)	7/8"	1/4"	for 17mm Shank
85301	(d.)	1"	1/4"	
85301-A	(e.)	1"	1/4"	

Jaw Slides



P/N		Tube Size	Pin Size	Description
87082	(a.)	7/8"	1/4"	1/4-28 Set Screw
87082A		7/8"	1/4"	Threaded like 87082 but No Bolt & Set Screw
87082S		7/8"	Drilled for Pin	1/4-28 Set Screw
87083		1"	1/4"	1/4-28 Set Screw
87517		3/4"	1/4"	1/4-28 Set Screw
87519	(b.)	1-1/4"	5/16"	1/4-28 Set Screws (2)

Open Jaw Slides



P/N	Tube Size	Pin Size	Description
87425	7/8"	1/4"	5mm Set Hole

Specialty Jaw Slides



P/N		Tube Size	Pin Size	Description
87428	(a.)	7/8"	1/4"	Offset with 1/4-28 Set Screw
87429	(b.)	7/8"	1/4"	Swivel Double with 1/4-28 Set Screw
87433	(c.)	7/8"	1/4"	1/4-28 Set Screw & 3/16" Rivet Hole
87435		1"	1/4"	Swivel Double with 1/4-28 Set Screws
87471		7/8"	1/4"	Two 3/16" Rivet Holes & Tapped for 1/4" Bolt (not incl.)

◆◆◆ ALL PRODUCTS ARE STAINLESS STEEL UNLESS OTHERWISE NOTED ◆◆◆

TO ORDER, CALL PRIME INDUSTRIES, INC. 1-800-446-1144

Top Fittings

P/N	Tube Size	Pin Size		EZ Mount Jaw Slides
86001	7/8"	1/4"		
86002	1"	1/4"		
87417	1-1/4"	1/4"		

P/N	Base Size	Pin Size	Fastener		90° Deck Hinges
87086	11/16" x 2-1/4"	1/4"	#10 (2)		
87086S	11/16" x 2-1/4"	Drilled for Pin	#10 (2)		

P/N	Base Size	Pin Size	Fastener		90° Heavy Duty Deck Hinge
87520	1" x 2-1/8"	5/16"	1/4" (2)		

P/N	Base Size	Pin Size	Fastener		Concave Base Deck Hinges
87087	3/4" x 2-1/4"	1/4"	#10 (2)		
87087S	3/4" x 2-1/4"	Drilled for Pin	#10 (2)		

P/N	Base Size	Pin Size	Fastener		Angle Base Deck Hinges
87088	11/16" x 2-1/4"	1/4"	#10 (2)		
87088-S	11/16" x 2-1/4"	Drilled for Pin	#10 (2)		

P/N	Desc.	Base Size	Fastener		Swivel Deck Hinge & Seat
87418	(a.) Swivel Deck Hinge	13/16" x 2-5/8"	#10 (2)		
87419	(b.) Swivel Deck Hinge Seat	13/16" x 2-5/8"	#10 (2)		

P/N	Desc.	Base Size	Fastener		Lo-Pro Swivel Deck Hinge
87434	Lo-Pro Swivel Deck Hinge	1-1/4" x 2-15/16"	#10 (2)		

P/N	Base Size	Pin Size	Fastener		Side Mount Deck Hinge
87089	7/8" x 2"	1/4"	#10 (2)		

◆◆ ALL PRODUCTS ARE STAINLESS STEEL UNLESS OTHERWISE NOTED ◆◆

TO ORDER, CALL PRIME INDUSTRIES, INC. 1-800-446-1144

Top Fittings

Heavy Duty Deck Plate



P/N	Base Size	Pin Size	Fastener
87093	1-7/8" x 2-3/4"	1/4"	1/4" Screws

Z Mounts



P/N	Description	Base Size	Pin Size	Fastener
85312 (a.)	Z Mount	7/8" x 1-5/8"	1/4"	#10 (2)
85329 (b.)	Z Mount Seat	7/8" x 1-5/8"	1/4"	#10 (2)
86315 (c.)	Concave Mount	7/8" x 1-5/8"	1/4"	#10 (2)

Pad Eyes

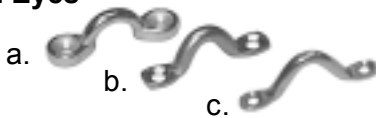

P/N	Description	Length	Height	Fastener
87311 (a.)	Cast	2"	9/16"	#10 (2)
S87311 (b.)	Stamped	2"	9/16"	#10 (2)
S87311TM (c.)	Stamped	2-1/16"	11/16"	#8 (2)

Side Mounts/ Windshield Mounts



P/N	Type	Description
85550	90° Concave	Rectangular
85551	75° Concave	Rectangular
85552	90° Concave	Round
85553	75° Concave	Round
85554	110° Concave	Round

Zipper Sliders



P/N	Desc.	Type
87412	S/S Single	Non-Locking
87413	S/S Single	Locking
87414	S/S Double	Non-Locking
87415	S/S Double	Locking

Pull Pins & Accessories

Spring Pull Pin



P/N	Size	Grip
85316	1/4" O.D.	3/4"

Quick Release Pin



P/N	Size	Grip
87155	1/4" O.D.	7/8"

◆◆◆ ALL PRODUCTS ARE STAINLESS STEEL UNLESS OTHERWISE NOTED ◆◆◆

TO ORDER, CALL PRIME INDUSTRIES, INC. 1-800-446-1144

Pull Pins & Accessories

P/N	Description
7199 (a.)	6" S/S Nylon Coated without Tab
7167 (b.)	6" S/S Nylon Coated with Tab

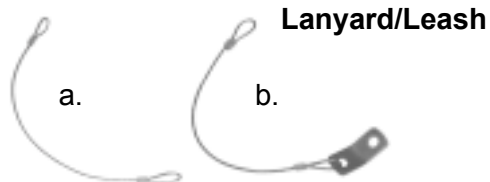

P/N	Size	Grip	Cable
87431 (a.)	1/4" O.D.	3/4"	6" S/S nylon coated without tab
88548 (b.)	1/4" O.D.	3/4"	6" S/S nylon coated with tab



P/N	Size	Grip	Cable
88547	1/4" O.D.	7/8"	6" S/S nylon coated with tab



Noise Reduction Top Fittings

P/N	Tube Size	Pin Size	Description
87079NR	7/8"	For 1/4" Release Pin	1/4-28 Set Screw
87080NR	1"	For 1/4" Release Pin	1/4-28 Set Screw



P/N	Tube Size	Pin Size	Description
86006NR	7/8"	For 1/4" Release Pin	for 19.5mm Shank
86009NR	7/8"	For 1/4" Release Pin	for 18.8mm Shank



P/N	Tube Size	Pin Size	Description
87082NR	7/8"	For 1/4" Release Pin	1/4-28 Set Screw
87083NR	1"	For 1/4" Release Pin	1/4-28 Set Screw



P/N	Base Size	Pin Size	Fastener
87086NR	7/8" x 1-5/8"	For 1/4" Release Pin	#10 (2)



◆◆ ALL PRODUCTS ARE STAINLESS STEEL UNLESS OTHERWISE NOTED ◆◆

TO ORDER, CALL PRIME INDUSTRIES, INC. 1-800-446-1144

Snap Hooks & Additional Hardware

90° Eye Snap Hooks	P/N	Eye Size	Total Length
	249S-0	3/8"	2-17/32"
	249S-1	5/8"	3-9/32"



1" Square Eye Snap Hook	P/N	Description
	86014	S/S 1" Square Eye

Stainless Steel Wire Spring	P/N	Webbing Size
	142A-S	1"



Stainless Steel 1" Buckle	P/N	Description
	146L	S/S Buckle for 1" Webbing

Stainless Steel "D" Ring	P/N	Size
	88998	1" x 3/16" Welded

Hawse Pipes

Hawse Pipes	P/N	Flange	Int. Hole	Depth	Fastener
a. 	87018	(a.) 5.5" x 2.5"	1.5" x 3.75"	.88"	#10 (4)
b. 	84003	(b.) 6.5" x 4.75"	4.5" x 2.82"	1.94"	#10 (3)

Bollards

Bollards	P/N	Description	Fastener
a. 	84520	(a.) 4-3/4" Bollard	3/8" (4)
b. 	86022	(b.) 7" Bollard	3/8" (4)

◆◆◆ ALL PRODUCTS ARE STAINLESS STEEL UNLESS OTHERWISE NOTED ◆◆◆

TO ORDER, CALL PRIME INDUSTRIES, INC. 1-800-446-1144

Thru-Hulls

P/N	Hose Size	A	B	C	D	E	Drill Hole Size	Thru-Hulls
86036	5/8"	1.50"	.875"	1.70"	1.30"	.625"	7/8"	
86037	3/4"	1.50"	1.10"	1.70"	1.30"	.75"	7/8"	
86038	1"	2.00"	1.36"	1.70"	1.50"	1.00"	1-3/8"	
86039	1-1/8"	2.00"	1.30"	1.70"	1.70"	1.125"	1-3/8"	
86040	1-1/4"	2.70"	1.65"	1.80"	1.80"	1.25"	1-3/4"	
86041	1-1/2"	2.75"	1.87"	2.00"	1.80"	1.50"	1-3/4"	
86042	2"	2.40"	2.02"	2.00"	2.00"	2.00"	2-3/8"	

Bow Eyes

P/N	Thread	A	B	C	D	E	Bow Eyes with Regular Nuts
84042	3/8"	3/8"	3"	1-1/16"	4-1/2"	1-7/16"	
84046	3/8"	3/8"	4"	1-1/16"	5-3/8"	1-1/2"	
84054	1/2"	1/2"	3"	1-5/16"	5"	1-13/16"	
84056	1/2"	1/2"	3-7/16"	1-3/8"	5-1/2"	1-15/16"	
84058	1/2"	1/2"	4"	1-5/16"	6"	1-7/8"	
84060	1/2"	1/2"	4-3/4"	1-3/8"	6-3/4"	1-15/16"	
84042L	3/8"	3/8"	3"	1-1/16"	4-1/2"	1-7/16"	
84046L	3/8"	3/8"	4"	1-1/16"	5-3/8"	1-1/2"	
84054L	1/2"	1/2"	3"	1-5/16"	5"	1-13/16"	
84056L	1/2"	1/2"	3-7/16"	1-3/8"	5-1/2"	1-15/16"	
84058L	1/2"	1/2"	4"	1-5/16"	6"	1-7/8"	
84060L	1/2"	1/2"	4-3/4"	1-3/8"	6-3/4"	1-15/16"	
84095	1/2"	1/2"	3"	1-5/16"	5"	1-13/16"	
84096	1/2"	1/2"	3-7/16"	1-3/8"	5-1/2"	1-15/16"	
84097	1/2"	1/2"	4"	1-5/16"	6"	1-7/8"	
84098	1/2"	1/2"	4-3/4"	1-3/8"	6-3/4"	1-15/16"	
84095L	1/2"	1/2"	3"	1-5/16"	5"	1-13/16"	
84096L	1/2"	1/2"	3-7/16"	1-3/8"	5-1/2"	1-15/16"	
84097L	1/2"	1/2"	4"	1-5/16"	6"	1-7/8"	
84098L	1/2"	1/2"	4-3/4"	1-3/8"	6-3/4"	1-15/16"	

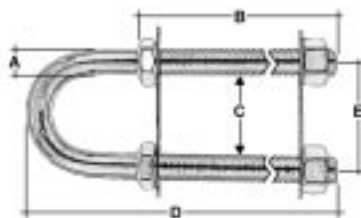

◆◆ ALL PRODUCTS ARE STAINLESS STEEL UNLESS OTHERWISE NOTED ◆◆

TO ORDER, CALL PRIME INDUSTRIES, INC. 1-800-446-1144

Rod Holders

90° Rod Holder
Oval Face



P/N
87527

Description
Oval Face,
w/White Insert
& Gasket

A	B	C	D	E	F	G
4-1/4"	1-1/8"	1-1/8"	N/A	2"	8-1/4"	1"

**0 DEGREE
ROD HOLDER**

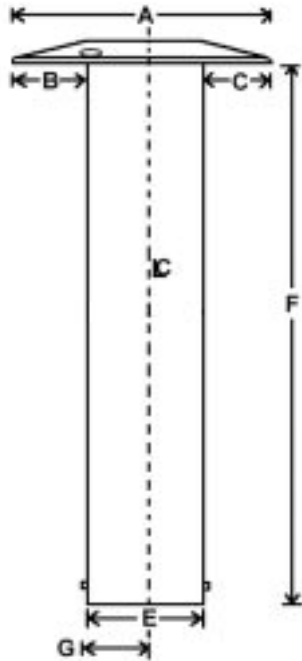

**15 DEGREE
ROD HOLDER**

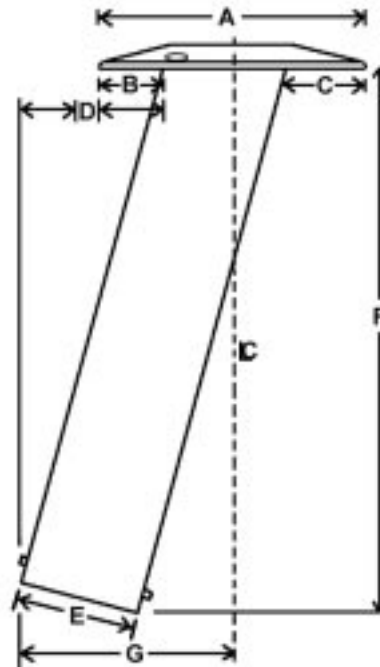

15° Rod Holder
Oval Face



87526

Description
Oval Face
w/White Insert
& Gasket

A	B	C	D	E	F	G
4-1/4"	1"	1-1/8"	2-1/4"	2"	8"	3-1/4"

◆◆◆ ALL PRODUCTS ARE STAINLESS STEEL UNLESS OTHERWISE NOTED ◆◆◆

TO ORDER, CALL PRIME INDUSTRIES, INC. 1-800-446-1144

Rod Holders

P/N	Description	A	B	C	D	E	F	G	
87502	No Weld	4-1/4"	7/8"	1-1/8"	4"	2"	7-3/4"	5"	30° Rod Holder Oval Face



87503	White Insert & Cap w/Gasket	4-1/4"	7/8"	1-1/8"	4"	2"	7-1/4"	5"	30° Rod Holder Oval Face
-------	--------------------------------	--------	------	--------	----	----	--------	----	-----------------------------



87504	Black Insert & Cap w/Gasket	4-1/4"	7/8"	1-1/8"	4"	2"	7-1/4"	5"	30° Rod Holder Oval Face
-------	--------------------------------	--------	------	--------	----	----	--------	----	-----------------------------



30 DEGREE ROD HOLDER

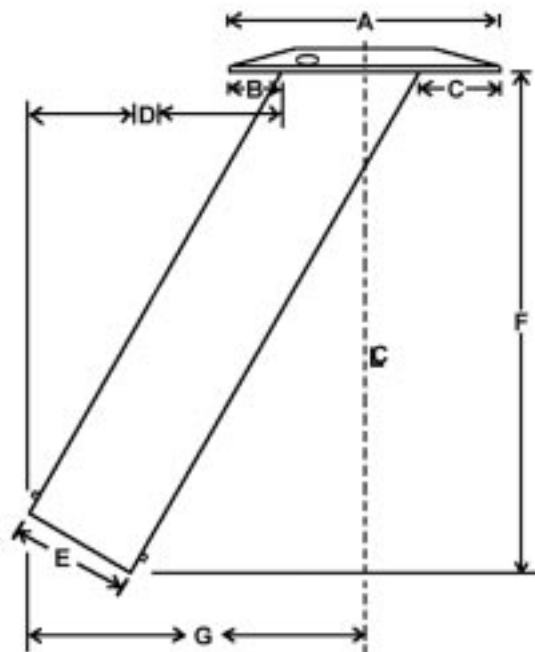

◆◆ ALL PRODUCTS ARE STAINLESS STEEL UNLESS OTHERWISE NOTED ◆◆

TO ORDER, CALL PRIME INDUSTRIES, INC. 1-800-446-1144

Rod Holders

30° Rod Holder
Oval Face



P/N
87509-1

Description
White Insert
& Gasket

A 4-1/4" B 7/8" C 1-1/8" D 4" E 2" F 8" G 5"

30° Rod Holder
Oval Face



87509B-1

Description
Black Insert
& Gasket

A 4-1/4" B 7/8" C 1-1/8" D 4" E 2" F 8" G 5"

30° Rod Holder
Oval Face



87509BC

Description
Black Insert
w/Cap & Gasket

A 4-1/4" B 7/8" C 1-1/8" D 4" E 2" F 8" G 5"

30° Rod Holder
Stamped



87515

Description
Stamped
w/Black Insert
w/Cap & Gasket

A 4-1/4" B 1-1/8" C 1-1/8" D 4" E 2" F 7-3/4" G 5-1/2"

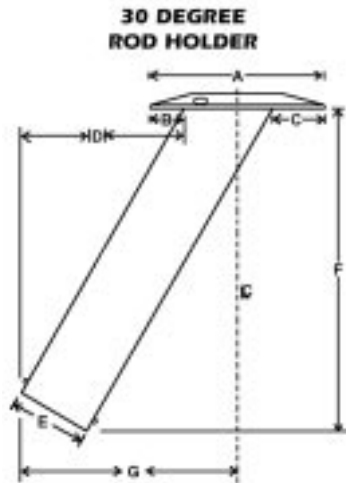

◆◆ ALL PRODUCTS ARE STAINLESS STEEL UNLESS OTHERWISE NOTED ◆◆

TO ORDER, CALL PRIME INDUSTRIES, INC. 1-800-446-1144

Rod Holder Accessories

P/N	Description
87503-GC	(a.) White Gasket w/Cap
87504-GC	(b.) Black Gasket w/Cap
87509WG	(c.) White Gasket for 87509-1 & 87503
87509B-G	(d.) Black Gasket for 87509B-1 & 87504
87509-I	(e.) White Insert for 87509-1
87509B-I	(f.) Black Insert for 87509B-1
87509B-IC	(g.) Black Insert w/Cap
87509-D	(h.) Black Plastic Drain

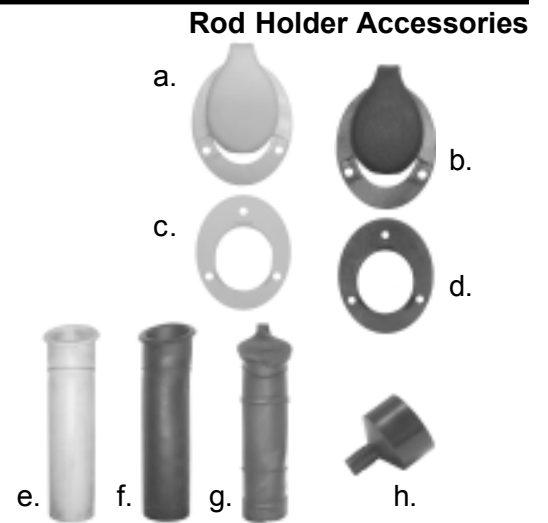

Other Parts

P/N	Description	Fastener
M6708	(a.) Strut	3/8" (6)
FIN65	(b.) FIN #65	1/4" (6)



P/N	Base Size	Height
87508	2" x 3-1/2"	5"
87163	3-3/4" x 2-13/64"	6"



P/N	Description	Thread	Eye Diameter
3510	Short Ski Tow	1-1/4" without Nut	2-1/2"



P/N	Description
87104	(a.) 1/4-28 Set Screw
87194	(b.) 1/4" Bolt for 3/4", 7/8" & 1" Jaw Slides & Deck Hinges
87195	(c.) 5/16" Bolt for 1-1/4" Jaw Slide & Heavy Duty Deck Hinge
86015	(d.) Balster Clip 1-3/16" W x 2-13/16" L, 1/2" Offset



♦♦♦ ALL PRODUCTS ARE STAINLESS STEEL UNLESS OTHERWISE NOTED ♦♦♦

TO ORDER, CALL PRIME INDUSTRIES, INC. 1-800-446-1144

Base Rail Fittings

30° Round Base	P/N	Tube O.D.	Base	Fastener
	87029	7/8"	2.5" O.D.	#10 (3)
	87030	1"	2.8" O.D.	1/4" (3)

With 1/4-28 Set Screws.

45° Round Base	P/N	Tube O.D.	Base	Fastener
	87031	7/8"	2.5" O.D.	#10 (3)
	87031-1	1"	2.8" O.D.	1/4" (3)

With 1/4-28 Set Screws.

60° Round Base	P/N	Tube O.D.	Base	Fastener
	87032	7/8"	2.5" O.D.	#10 (3)
	87033	1"	2.8" O.D.	1/4" (3)
	87529	1-1/4"	3.07" O.D.	1/4" (3)



With 1/4-28 Set Screws.

90° Round Base	P/N	Tube O.D.	Base	Fastener
	87034	7/8"	2.5" O.D.	#10 (3)
	87035	1"	2.8" O.D.	1/4" (3)
	87530	1-1/4"	3" O.D.	1/4" (3)



With 1/4-28 Set Screws.

30° Rectangular Base	P/N	Tube O.D.	Base	Fastener
	87036	7/8"	3" x 1.7"	#10 (3)
	87036-1	1"	3.5" x 1.9"	1/4" (3)

With 1/4-28 Set Screws.

45° Rectangular Base	P/N	Tube O.D.	Base	Fastener
	87037	7/8"	3" x 1.7"	#10 (4)
	87037-1	1"	3.2" x 1.9"	1/4" (4)

With 1/4-28 Set Screws.

◆◆◆ ALL PRODUCTS ARE STAINLESS STEEL UNLESS OTHERWISE NOTED ◆◆◆

TO ORDER, CALL PRIME INDUSTRIES, INC. 1-800-446-1144

Base Rail Fittings

P/N	Tube O.D.	Base	Fastener
87038	7/8"	3" x 1.7"	#10 (4)
87039	1"	3.2" x 1.8"	1/4" (4)
87532	1-1/4"	1.44" x 1.88"	1/4" (4)



With 1/4-28 Set Screws.



60°
Rectangular
Base

P/N	Tube O.D.	Base	Fastener
87040	7/8"	2.8" x 1.7"	#10 (4)
87041	1"	3" x 1.8"	1/4" (4)
87531	1-1/4"	3.25 x 1.88"	1/4" (4)



With 1/4-28 Set Screws.



90°
Rectangular
Base

P/N	Tube O.D.	Base	Ht.	Fastener
87042	7/8"	1.2" x 2.8"	1.4"	1/4" (2)
87043	1"	1.3" x 2.8"	1.4"	1/4" (2)

With 1/4-28 Set Screws.



90° 2-Hole
Rectangular
Base

Elbows

P/N	Tube O.D.
87075	7/8"
87076	1"
87528	1-1/4"



With 1/4-28 Set Screws.



Elbows

P/N	Tube O.D.
88288	7/8"
88289	1"

With 1/4-28 Set Screws.



3-Way
Corner
All 90°

◆◆ ALL PRODUCTS ARE STAINLESS STEEL UNLESS OTHERWISE NOTED ◆◆

TO ORDER, CALL PRIME INDUSTRIES, INC. 1-800-446-1144

Tee Rail Fittings

60°
Universal
Tee



P/N	Tube O.D.
87046	7/8"
87047	1"
87533	1-1/4"

With 1/4-28 Set Screws.

90°
Tee



P/N	Tube O.D.
87054	7/8"
87055	1"
87534	1-1/4"

With 1/4-28 Set Screws.

Large Rail Fittings



Short Round
Base

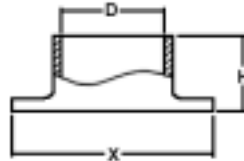

P/N	D	H	X
88103-150	1-1/2"	28mm	75mm O.D.
88103-200	2"	30mm	103mm O.D.

With One 1/4-28 Set Screw

90° Elbow
Male
Ends

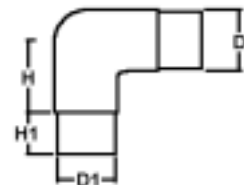

P/N	D	H	D1	H1
88104-125	1-1/4"	30mm	28.65mm O.D.	25mm
88104-150	1-1/2"	45mm	35mm O.D.	25mm
88104-200	2"	50mm	47.7mm O.D.	25mm

For .049" Tube Wall Thickness

3-Way Corner (All 90°)
Male Ends

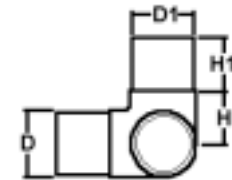

P/N	D	H	D1	H1
88110-150	1-1/2"	35mm	35mm O.D.	25mm
88110-200	2"	35mm	47.7mm O.D.	25mm

For .049" Tube Wall Thickness

3-Way Tee
Male Ends

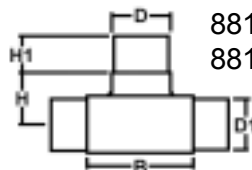
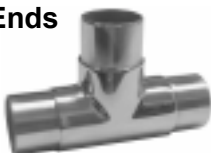

P/N	D	H	B	D1	H1
88111-150	1-1/2"	35mm	70mm	35mm O.D.	25mm
88111-200	2"	35mm	70mm	47.7mm O.D.	25mm

For .049" Tube Wall Thickness

◆◆◆ ALL PRODUCTS ARE STAINLESS STEEL UNLESS OTHERWISE NOTED ◆◆◆

TO ORDER, CALL PRIME INDUSTRIES, INC. 1-800-446-1144



Large Rail Fittings

P/N	D	H	D1	H1
88114-100	1"	27.7mm	22.3mm O.D.	14mm
88114-150	1-1/2"	34.05mm	35mm O.D.	20mm
88114-200	2"	40.4mm	47.7mm O.D.	25mm

For .049" Tube Wall Thickness

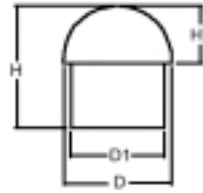

P/N	D	H	D1	H1
88119-150	1-1/2"	45mm	35mm O.D.	25mm
88119-200	2"	50mm	47.7mm O.D.	25mm

For .049" Tube Wall Thickness



P/N	D	H	D1	H1
88120-150	1-1/2"	45mm	35mm O.D.	25mm
88120-200	2"	50mm	47.7mm O.D.	25mm

For .049" Tube Wall Thickness

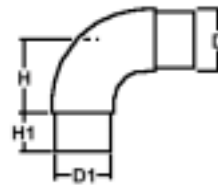

Hand Rail Fittings

P/N	Tube O.D.	Desc.	Height	Fastener
87059	7/8"	60°	1-1/2"	#10 (2)
87059-1	1"	60°	1-3/4"	#10 (2)



P/N	Tube O.D.	Desc.	Height	Fastener
87060	7/8"	Ctr.	1-1/2"	#10 (2)
87061	1"	Ctr.	1-3/4"	#10 (2)



P/N	Tube O.D.	Desc.	Height	Fastener
87064	7/8"	60°	1-1/2"	#10 (2)
87065	1"	60°	1-3/4"	#10 (2)



P/N	Tube O.D.	Desc.	Height	Fastener
87214	7/8"	End	1-1/2"	1/4"

With 1/4-28 Set Screws.



◆◆ ALL PRODUCTS ARE STAINLESS STEEL UNLESS OTHERWISE NOTED ◆◆

TO ORDER, CALL PRIME INDUSTRIES, INC. 1-800-446-1144

Rings

Lift Ring Cleat Combo



P/N	Length	Eye Dia.	Fastener	Max. Ld. (Lb.)
87026	6"	1-1/8"	#10 (2)	4000
87027	7"	1-1/2"	1/4" (2)	5000

Lift Ring



P/N	Base Dia.	Eye Dia.	Fastener	Max. Ld. (Lb.)
87511	2-1/4"	1-1/2"	#10 (2)	4000

Lift Ring



P/N	Base Size	Eye Dia.	Fastener	Max. Ld. (Lb.)
86343	7/8" x 2-1/4"	1-1/8"	#10 (2)	3000

ANGULAR LOADING. Due to the many variances that arise, no guarantee of actual performance is possible for angular loading. Published figures, herein, are for guide purposes only.

MAX. WORKING LOADS. These figures have been determined on the basis of the load being applied in the direction of the axis of the shank for each Eye listed. Bolt Size: 5/8-11. Listed lifting loads are for reference only. No guarantee of actual lifting performance is made. Regular inspection of lift rings is recommended to ensure proper performance.

Hinges

Strap Hinge



P/N	Size	Fastener
87115 (a.)	4" x 1"	#10 (4)
87116 (b.)	6" x 1-1/8"	#10 (6)

Butt Hinge



P/N	Size	Fastener
87117 (a.)	1-1/2" x 1-1/2"	#10 (4)
87118 (b.)	2" x 2"	#10 (4)

◆◆◆ ALL PRODUCTS ARE STAINLESS STEEL UNLESS OTHERWISE NOTED ◆◆◆

TO ORDER, CALL PRIME INDUSTRIES, INC. 1-800-446-1144

Hinges

P/N	Size	Fastener
87121	(a.) 1-1/2" x 3"	#8 (6)
87122	(b.) 1-1/2" x 4"	#10 (6)



P/N	Size	Fastener
87442	1-9/16" x 2-3/4"	#10 (4)

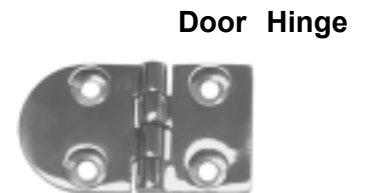

P/N	Size	Fastener
87443	1-1/2" x 3"	#8 (6)



P/N	Size	Fastener	"A"
87119	(a.) 1-1/2" x 2-1/4"	#10 (5)	.75"
87120	(b.) 1-1/2" x 3"	#10 (5)	.75"



P/N	Size	Fastener
87125	1-1/2" x 3-1/2"	#10 (4)



P/N	Size	Fastener
87126	(a.) 3" x 2-1/2"	#10 (8)



87514	(b.) 3" x 3-5/8" with 1-3/8" opening	#10 (8)
-------	--------------------------------------	---------



◆◆ ALL PRODUCTS ARE STAINLESS STEEL UNLESS OTHERWISE NOTED ◆◆

TO ORDER, CALL PRIME INDUSTRIES, INC. 1-800-446-1144

End Caps

End Caps Custom Designs

Rub Rail Profile

P/N

Description

Type

87403L

Small End Cap

Left

87403R

Small End Cap

Right



87404L

Large End Cap

Left

87404R

Large End Cap

Right



87405L

X-Large End Cap

Left

87405R

X-Large End Cap

Right



87408L

End Cap (AL)

Left

87408R

End Cap (AL)

Right



◆◆◆ ALL PRODUCTS ARE STAINLESS STEEL UNLESS OTHERWISE NOTED ◆◆◆

TO ORDER, CALL PRIME INDUSTRIES, INC. 1-800-446-1144

End Caps

P/N	Description	Type	Rub Rail Profile	End Caps Custom Designs
87411L 87411R	End Cap End Cap	Left Right		
87421	End Cap, Flat Face	Fits Left & Right		
87437L 87437R	End Cap (New) End Cap (New)	Left Right		
87423L 87423R	End Cap "F" End Cap "F"	Left Right		

◆◆ ALL PRODUCTS ARE STAINLESS STEEL UNLESS OTHERWISE NOTED ◆◆

TO ORDER, CALL PRIME INDUSTRIES, INC. 1-800-446-1144

End Caps

End Caps Custom Designs

Rub Rail Profile

P/N

Description

Type

87456L
87456R

End Cap
End Cap

Left
Right



87459L
87459R

Small End Cap
Small End Cap

Left
Right



87461L
87461R

End Cap
End Cap

Left
Right



87462L
87462R

End Cap, No Edge
End Cap, No Edge

Left
Right

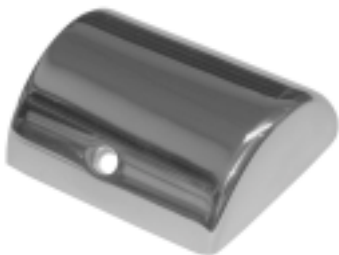

◆◆◆ ALL PRODUCTS ARE STAINLESS STEEL UNLESS OTHERWISE NOTED ◆◆◆

TO ORDER, CALL PRIME INDUSTRIES, INC. 1-800-446-1144

Specialty Items

Proprietary Products

If you need unique parts, Prime Industries, Inc. can assist in the development of these proprietary items - from design through manufacture and delivery.

If this is of interest to you, we look forward to working with your company to develop the products that set the standards for the future.

The following pages are of some of our proprietary parts. This is for reference only.

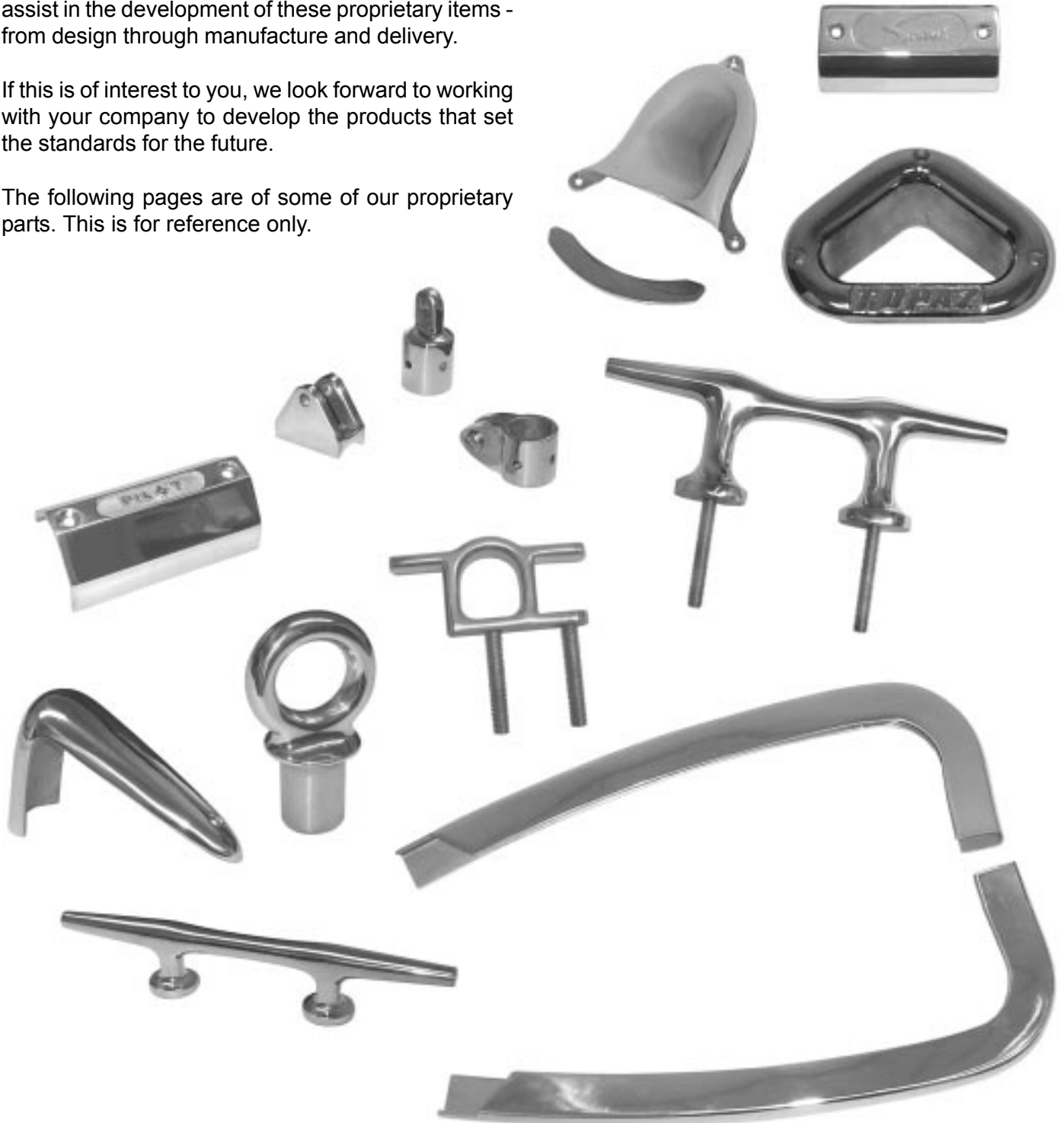

◆◆ ALL PRODUCTS ARE STAINLESS STEEL UNLESS OTHERWISE NOTED ◆◆

TO ORDER, CALL PRIME INDUSTRIES, INC. 1-800-446-1144



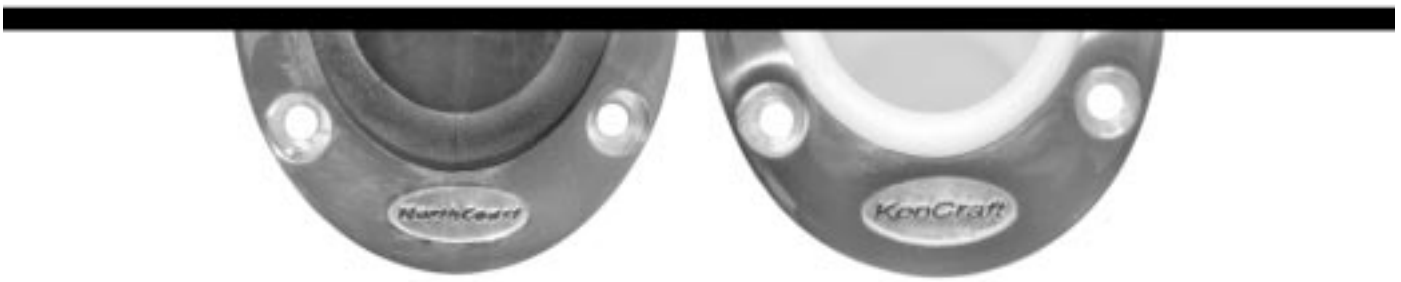









Rod Holders with Logos



◆◆◆ ALL PRODUCTS ARE STAINLESS STEEL UNLESS OTHERWISE NOTED ◆◆◆

TO ORDER, CALL PRIME INDUSTRIES, INC. 1-800-446-1144









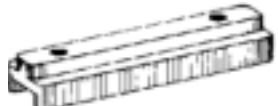

Nylon Parts

Nylon Parts	P/N	Description	Color
	87261	7/8" Inside Eye End	Black
	87262	7/8" Inside Eye End	Natural
	87263	7/8" Outside Eye End	Black
	87264	7/8" Outside Eye End	Natural
	87265	7/8" Jaw Slide	Black
	87266	7/8" Jaw Slide	Natural
	87267	2 Hole Side Mount	Black
	87268	2 Hole Side Mount	Natural
	87269	90° Deck Hinge w/Bolt	Black
	87270	90° Deck Hinge w/Bolt	Natural
	87273	Angled Deck Hinge w/Bolt	Black
	87274	Angled Deck Hinge w/Bolt	Natural
	87271	90° Sm Deck Hinge w/Bolt	Black
	87272	90° Sm Deck Hinge w/Bolt	Natural
	87275	Concave Base Rail Hinge w/Bolt	Black
	87276	Concave Base Rail Hinge w/Bolt	Natural
	87277	4 Hole Side Mount	Black
	87278	4 Hole Side Mount	Natural
	87281	5° Deck Hinge Wedge	Black
	87282	5° Deck Hinge Wedge	Natural
	87279	Eye Strap	Black
	87280	Eye Strap	Natural
	87283	Side Mount/Slide	Black
	87284	Side Mount/Slide	Natural
	87285	Slide Lock for .850 Track	Black
	87286	Slide Lock for .850 Track	Natural

◆◆ ALL PRODUCTS ARE STAINLESS STEEL UNLESS OTHERWISE NOTED ◆◆

TO ORDER, CALL PRIME INDUSTRIES, INC. 1-800-446-1144

Nylon Parts

P/N	Description	Color	Nylon Parts
87287	1/4"-20 Plastic Head Screw	Black	
87288	1/4"-20 Plastic Head Screw	Natural	
87289	Track Slide for Deck Hinge	Black	
87290	Track Slide for Deck Hinge	Natural	
87291	Deck Hinge Slide Comb	Black	
87292	Deck Hinge Slide Comb	Natural	
87297	T-7 Knob Set Screw	Black	
87293	Deck Hinge Slide Lock Comb (L)	Black	
87294	Deck Hinge Slide Lock Comb (L)	Natural	
87295	Deck Hinge Slide Lock Comb (R)	Black	
87296	Deck Hinge Slide Lock Comb (R)	Natural	
87299	Rail Hinge Adapter	Black	
87300	Rail Hinge Adapter	Natural	
87301	Window Spacer 7/8"	White	
87302	Window Spacer 1"	White	
87304	Slide Kit	Black	
87308	Slide Kit	Natural	
87309	Channel End Cap for .850 Track	Black	
87310	Channel End Cap for .850 Track	White	
87298	Quick Release Pin	Black	
87303	Combo Spacer/Top Frame Lock 7/8"	White	
87315	7/8" Rigid Support Clip	Black	

◆◆ ALL PRODUCTS ARE STAINLESS STEEL UNLESS OTHERWISE NOTED ◆◆

TO ORDER, CALL PRIME INDUSTRIES, INC. 1-800-446-1144

Die Cast Parts

Heavy Duty
Die Cast
Eye End



P/N
D87079

Tube Size
7/8"

Pin Size
1/4"

Description
1/4-28
Set Screw

Heavy Duty
Die Cast
Jaw Slide



P/N
D87082

Tube Size
7/8"

Pin Size
1/4"

Description
1/4-28
Set Screw

Heavy Duty
Die Cast
90° Deck
Hinge



P/N
D87086

Base Size
3/4" x 2-7/16"

Pin Size
1/4"

Fastener
#10 (2)

Heavy Duty
Die Cast
Side Mount
Deck Hinge



P/N
D87089

Base Size
.90" x 1-15/16"

Pin Size
1/4"

Fastener
#10 (2)

Heavy Duty
Die Cast
Eye Strap



P/N
D87311

Length
1-7/8"

Height
9/16"

Fastener
#10 (2)

♦♦♦ ALL PRODUCTS ARE STAINLESS STEEL UNLESS OTHERWISE NOTED ♦♦♦

TO ORDER, CALL PRIME INDUSTRIES, INC. 1-800-446-1144

Index by Part Number

Part #	Page #	Part #	Page #	Part #	Page #	Part #	Page #
142A-S	8	86009	4	87035	14	87117	18
146L	8	86009NR	7	87036	14	87118	18
249S-0	8	86014	8	87036-1	14	87119	19
249S-1	8	86015	13	87037	14	87120	19
3510	13	86022	8	87037-1	14	87121	19
7167	7	86031	3	87038	15	87122	19
7199	7	86032	1	87039	15	87125	19
84001	1	86033	1	87040	15	87126	19
84002	1	86034	1	87041	15	87137	3
84003	8	86035	1	87042	15	87138	3
84042	9	86036	9	87043	15	87139	3
84042L	9	86037	9	87046	16	87140	3
84046	9	86038	9	87047	16	87141	3
84046L	9	86039	9	87054	16	87141/L	3
84054	9	86040	9	87055	16	87141/L-1	3
84054L	9	86041	9	87059	17	87142	3
84056	9	86042	9	87059-1	17	87146	3
84056L	9	86043	4	87060	17	87155	6
84058	9	86315	6	87061	17	87163	13
84058L	9	86343	18	87064	17	87194	13
84060	9	87001	1	87065	17	87195	13
84060L	9	87002	1	87075	15	87214	17
84095	9	87002H	1	87076	15	87261	26
84095L	9	87003	1	87079	4	87262	26
84096	9	87003H	1	87079NR	7	87263	26
84096L	9	87004	1	87080	4	87264	26
84097	9	87005	1	87080NR	7	87265	26
84097L	9	87006	1	87082	4	87266	26
84098	9	87007	1	87082A	4	87267	26
84098L	9	87011	2	87082NR	7	87268	26
84520	8	87012	2	87082S	4	87269	26
85301	4	87013	2	87083	4	87270	26
85301-A	4	87014	2	87083NR	7	87271	26
85312	6	87015	2	87086	5	87272	26
85316	6	87016	2	87086NR	7	87273	26
85329	6	87018	8	87086S	5	87274	26
85550	6	87026	18	87087	5	87275	26
85551	6	87027	18	87087S	5	87276	26
85552	6	87029	14	87088	5	87277	26
85553	6	87030	14	87088-S	5	87278	26
85554	6	87031	14	87089	5	87279	26
86001	5	87031-1	14	87093	6	87280	26
86002	5	87032	14	87104	13	87281	26
86006	4	87033	14	87115	18	87282	26
86006NR	7	87034	14	87116	18	87283	26

◆◆ ALL PRODUCTS ARE STAINLESS STEEL UNLESS OTHERWISE NOTED ◆◆

TO ORDER, CALL PRIME INDUSTRIES, INC. 1-800-446-1144

Index by Part Number

Part #	Page #	Part #	Page #	Part #	Page #	Part #	Page #
87284	26	87408L	20	87462L	22	87531	15
87285	26	87408R	20	87462R	22	87532	15
87286	26	87411L	21	87471	4	87533	16
87287	27	87411R	21	87472	4	87534	16
87288	27	87412	6	87502	11	88103-150	16
87289	27	87413	6	87503	11	88103-200	16
87290	27	87414	6	87503-GC	13	88104-125	16
87291	27	87415	6	87504	11	88104-150	16
87292	27	87417	5	87504-GC	13	88104-200	16
87293	27	87418	5	87508	13	88110-150	16
87294	27	87419	5	87509-1	12	88110-200	16
87295	27	87421	21	87509-D	13	88111-150	16
87296	27	87423L	21	87509-I	13	88111-200	16
87297	27	87423R	21	87509B-1	12	88114-100	17
87298	27	87425	4	87509B-G	13	88114-150	17
87299	27	87428	4	87509B-I	13	88114-200	17
87300	27	87429	4	87509B-IC	13	88119-150	17
87301	27	87431	7	87509BC	12	88119-200	17
87302	27	87432	4	87509WG	13	88120-150	17
87303	27	87433	4	87511	18	88120-200	17
87304	27	87434	5	87514	19	88288	15
87308	27	87435	4	87515	12	88289	15
87309	27	87437L	21	87516	4	88547	7
87310	27	87437R	21	87517	4	88548	7
87311	6	87442	19	87518	4	88998	8
87315	27	87443	19	87519	4	D87079	28
87401	3	87446	2	87520	5	D87082	28
87402	3	87456L	22	87521D	3	D87086	28
87403L	20	87456R	22	87521G	3	D87089	28
87403R	20	87457	2	87526	10	D87311	28
87404L	20	87459L	22	87527	10	FIN65	13
87404R	20	87459R	22	87528	15	M6708	13
87405L	20	87461L	22	87529	14	S87311	6
87405R	20	87461R	22	87530	14	S87311TM	6

◆◆◆ ALL PRODUCTS ARE STAINLESS STEEL UNLESS OTHERWISE NOTED ◆◆◆

TO ORDER, CALL PRIME INDUSTRIES, INC. 1-800-446-1144

Product Warranty

Prime Industries, Inc.

Stainless Steel Hardware

Limited Warranty

Prime Industries Stainless Steel Boat Hardware is guaranteed to the original Purchaser, to be free from corrosion. This corrosion-free guarantee is in effect under normal use and service, for the life of the boat on which the product is originally installed. This guarantee is void if the product has been damaged by accident, unreasonable use, neglect, improper installation, unauthorized repairs or modifications, or other causes not arising due to defects in materials or workmanship. The product must be returned prepaid to Prime Industries for their review, together with proof of purchase. Under this warranty, Prime Industries' obligations are limited to repair or replacement of the product, at Prime Industries' expense and option. No other expense or liability will be assumed by Prime Industries.

This warranty gives the Purchaser certain rights, defined above, and the Purchaser may also have other rights, which may vary from state to state.

Prime Industries, Inc.
525 Central Drive
Virginia Beach, Virginia 23454

Tel: (757) 631-8899

Fax: (757) 631-0777

◆◆ ALL PRODUCTS ARE STAINLESS STEEL UNLESS OTHERWISE NOTED ◆◆

TO ORDER, CALL PRIME INDUSTRIES, INC. 1-800-446-1144

Alphabetical Index

	Page #
Base Rail Fittings NEW!	14-15
Bollards	8
Bow Eyes	9
Chocks	2
Deck Cleats	1-2
Deck Fills	3
Die Cast Parts	28
Elbows NEW!	15
End Caps	20-22
Hand Rail Fittings	17
Hawse Pipes	8
Hinges	18-19
Large Rail Fittings NEW!	16-17
Noise Reduction Top Fittings NEW!	7
Nylon Parts	26-27
Other Parts	13
Pull Pins & Accessories	6-7
Rings	18
Rod Holder Accessories	13
Rod Holders	10-12
Rod Holders with Logos	25
Snap Hooks & Additional Hardware	8
Specialty Items	23-24
Tee Tail Fittings NEW!	16
Thru-Hulls	9
Top Fittings	4-6

◆◆ ALL PRODUCTS ARE STAINLESS STEEL UNLESS OTHERWISE NOTED ◆◆

TO ORDER, CALL PRIME INDUSTRIES, INC. 1-800-446-1144

Terms and Conditions

1. Terms: Open accounts (Net 30) can be established by furnishing credit references on our Credit Application with acceptance of our terms and conditions.
All other shipments are C.O.D.
MasterCard, VISA, Discover, and American Express are also accepted.



2. Returned Checks: A \$25.00 fee will be applied to all returned checks.
3. Service Charges: A 1.5% service charge will be added to unpaid balances not paid within terms.
4. Freight: F.O.B. Virginia Beach, VA, unless other arrangements are made.
5. Freight Damage: Claims must be made IMMEDIATELY to the freight carriers and MUST BE NOTED ON THE BILL OF LADING. Late claims will not be accepted by the freight companies nor by us.
6. Return Policy: Defective merchandise may be returned for replacement after receiving a Returned Goods Authorization number from Prime Industries. Any products returned shall be freight prepaid. No C.O.D. shipments will be accepted. All returns must be made within 30 days of receipt and may be subject to a 20% restocking fee.

PRICES AND TERMS ARE SUBJECT TO CHANGE
WITHOUT NOTICE.

POSSESSION OF THIS OR OTHER LITERATURE DOES NOT
CONSTITUTE AN OFFER BY PRIME INDUSTRIES, INC. TO SELL TO
THE POSSESSOR.





PRIME
INDUSTRIES, INC.

525 Central Drive
Virginia Beach, Virginia 23454
Phone: (800) 446-1144
FAX Line: (757) 631-0777
In Virginia: (757) 631-8899
www.prime-industries.biz

02/09